



MNS & MNS *iS* Low Voltage Switchgear Safety Aspects

MNS and MNS iS is a registered trademark of ABB Automation Products GmbH.

ABB assumes no responsibility for any errors that may appear in this document. In no event shall ABB be liable for direct, indirect, special, incidental, or consequential damages of any nature or kind arising from the use of this document, nor shall ABB be liable for incidental or consequential damages arising from use of any software or hardware described in this document.

This document and parts thereof must not be reproduced or copied without ABB's written permission, and the contents thereof must not be imparted to a third party nor be used for any unauthorized purpose. The software described in this document is furnished under a license and may be used, copied, or disclosed only in accordance with the terms of such license.

All rights reserved.

Copyright 2012 © ABB Automation Products GmbH Ladenburg, Germany

Content

Proven Safety “Plus” for Operators and Plant	4
Type Tested Switchgear Assembly – Operators Advantage	6
Arc Fault Protection	8
Degrees of Protection provided by enclosures (IP Code)	14
Internal Separation	16
Earthquake, Vibration and Shock	18
Neutral conductor dimensioning	19

This compilation of Safety Aspects applies to the MNS platform, from the industry standard conventional, to the latest innovative design offered by MNS *i*S.

Explanatory technical information as well as lists of technical data on the above products can be obtained from the following documents:

MNS System Guide

Publication no. 1TGC902030B0202

MNS *i*S System Guide

Publication no. 1TGC910001B0204





Proven Safety “Plus” for Operators and Plant

Basic safety philosophy realized with MNS design

Universal rule to achieve a high safety level:

High protection of persons without compromise to the protection of the system

Protection classification into 2 priorities:

Priority 1: Active Protection

The occurrence of a failure is avoided.

Priority 2: Passive Protection

If a failure should occur it is limited to its place of occurrence, damage due to an arc is minimized.

The fulfillment of all instructions of IEC 61439-1 and -2 assures a basic level for Personal Protection and System Protection. ABB goes beyond this standard in cases where a high degree of exposure is anticipated, or specific risks (e.g. earthquake risk) have to be observed.

Thereby it was possible to reach an operational availability of the installed MNS boards world-wide of nearly 100%.

As illustrated in the schematic, additional measures are foreseen in these cases so that an even higher level of safety is reached to withstand the particular risks. This is guaranteed e.g. by the use of optimized material or specific constructions.

Example: Development of the standards and tests concerning resistance to internal arcs

ABB can rely on its experience with approximately 500 internal arcing tests carried out to-date.

As early as 1979, ABB already performed the first internal arcing tests on MNS, which at that time were still based on the medium-voltage standards VDE 0670 and IEC 60298 as well as the PEHLA standards. Of central importance was pure personal protection.

The first international standard regarding the performance of internal arcing tests in low-voltage switchgear systems was published in 1996 (IEC 61641 - VDE 0660 Part 500, additional sheet 2). The aim was to detect the effects of a possible internal arc on the safety of the operating personnel. As early as 1983, ABB adopted internal testing regulations for internal arcing tests which also referred to plant safety.

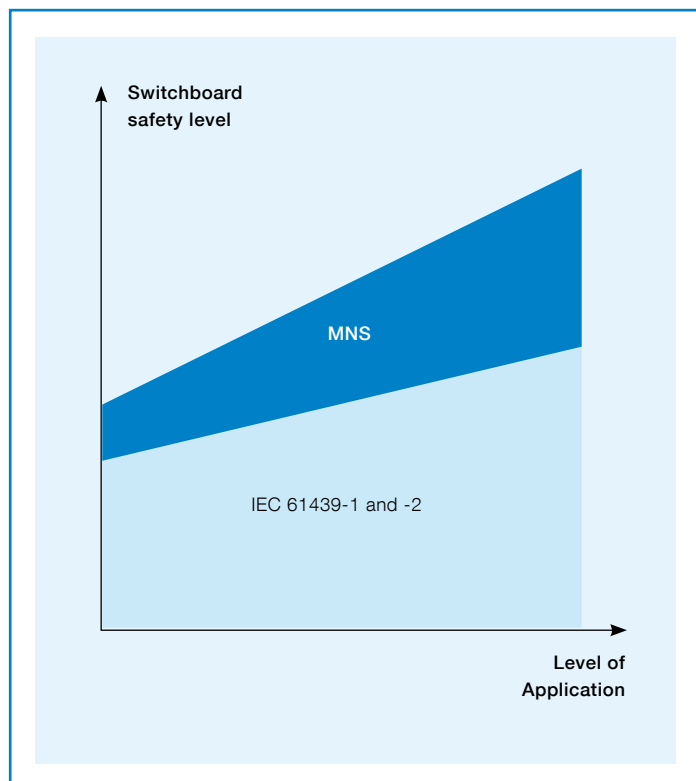

Power Switchgear Assembly – Operators Advantage

IEC 61439-1 and -2 classify tests which verify the characteristics of an assembly into:

- design verification (acc. paragraph 10)
- routine verification (acc. paragraph 11).

Design verification by test

Design verification is intended to verify compliance of the design of an ASSEMBLY or ASSEMBLY system with the requirements of this series of standards. The tests shall be carried out on a representative sample of an ASSEMBLY in a clean and new condition (IEC 61439-1 paragraph 10.1).

Where tests on the ASSEMBLY have been conducted in accordance with the IEC 60439 series, and the test results fulfill the requirements of the relevant part of IEC 61439, the verification of these requirements need not be repeated.

An ASSEMBLY which is verified in accordance with IEC 61439 by an original manufacturer and manufactured or assembled by another does not require the original design verifications to be repeated if all the requirements and instructions specified and provided by the original manufacturer are met in full. Where the ASSEMBLY manufacturer incorporates own arrangements not included in the original manufacturer's verification, the ASSEMBLY manufacturer is deemed to be the original manufacturer in respect of these arrangements.

The MNS low-voltage switchgear system is subjected to extensive design verifications and tests in compliance with the standards in order to ensure the highest possible degree of safety.

These tests are based on the most critical representative applications of the entire product or performance range of the switchgear with respect to the test standard. The results are documented in engineering guidelines and the ABB engineering tool used by local ABB organizations worldwide, applicable to the various low-voltage switchgear and control gear assemblies (in accordance with IEC 61439-1 and -2).

The safety level of the standard as well as a homogeneous quality are ensured in the way that the corresponding design and engineering documents as well as the manufacturing instructions are strictly followed.

Design verification by test (related section of IEC 61439-1)	Safety profit for operator and plant
Verification of temperature-rise (10.10)	Extended life cycle of the switchboard and equipment. Prevention of fire risks.
Verification of the dielectric properties (10.9)	Avoidance of damage caused by over-voltage.
Verification of the short-circuit withstand strength (10.11)	External influences can cause a short circuit. The switchboard arrangement can withstand the mechanical force of the short circuit. Limits the short circuit to the place of initiation. Prevention of fire risks.
Verification of protection against electric shock and integrity of the protective circuit (10.5)	Avoidance of fatal voltage at exposed conductive parts. Protection of personnel in case non current carrying parts accidentally become live. Protection against the consequences of faults in external circuits supplied through the ASSEMBLY.
Verification of clearances and creepage distances (10.4)	Environment influences can reduce the isolation quality (e.g. polluted area). MNS can be used in severe atmosphere.
Verification of mechanical operation (10.13)	Extended lifetime for moving components and equipments. MNS far exceeds the standard requirements.
Verification of the degree of protection (10.3)	Protection against live parts. Protection against penetration of liquid and solid elements. Ensures safe operation.
Verification of strength of materials and parts (10.2)	Protection against corrosion. Protection of insulating materials against abnormal heat and fire and ultra-violet radiation. Ensures safety regarding mechanical impacts and during lifting.

Routine verification during production of MNS switchboards

Routine verification is intended to detect faults in materials and workmanship and to ascertain proper functioning of the manufactured ASSEMBLY (IEC 61439-1 paragraph 11.1).

Routine verification is performed on every new ASSEMBLY/ shipping section following the defined manufacturing process.

Routine verification carried out consequently in the factory ensures the quality of ASSEMBLY, material and manufacturing. Guidelines such as inspection instructions and workshop checklists take into consideration all relevant mechanical and electrical properties. If required, additional routine verification can take place after erection.

Routine verification shall comprise the following categories:

- a) Construction (see 11.2 to 11.8)
- b) Performance (see 11.9 to 11.10)

Routine verification (related section of IEC 61439-1)	Safety profit for operator and plant
Verification of degree of protection of enclosures (11.2)	Ensures safety during operation.
Verification of clearance and creepage distances (11.3)	Ensures lifelong performance of the ASSEMBLY.
Verification of protection against electric shock and integrity of protective circuit (11.4)	Assures personal safety of operating personnel.
Verification of built-in components (11.5)	Ensures correct installation and identification of built-in components acc. to the ASSEMBLY manufacturer instructions.
Verification of internal electrical circuits and connections (11.6)	Ensures lifelong performance of the ASSEMBLY.
Verification of terminals for external conductors (11.7)	Ensures easy erection and installation.
Verification of mechanical operation (11.8)	Ensures correct mechanical function of mechanical actuating elements, interlocks, locks, removable parts etc.
Verification of dielectric properties (11.9)	Assures reliable operation and personal safety of operating personnel.
Verification of wiring, operational performance and function (11.10)	Ensures correct operation of the defined electrical functions incl. interlockings and sequence control facilities if applicable.



Arc Fault Protection

IEC 61641 Guide for testing under conditions of arcing due to internal fault:

This technical report applies to enclosed low-voltage switchgear and controlgear assemblies manufactured according to IEC 61439-1 and -2. This test is subject to an agreement between manufacturer and user. It is not considered to be a part of the standard design verification.

The sole purpose of this test is to assess the ability to the ASSEMBLY to limit the risk of personal injury resulting from an internal arcing fault. Since 2008, IEC 61641 is updated with criteria for ASSEMBLY protection and gives a testing guideline to limit the risk of a damage of the ASSEMBLY. Acc. IEC 61641 these criteria are optional to personal protection.

Despite the ever growing experience of the manufacturers and operators of switchgear and control gear systems, there is some residual risk of internal arc generation.

Internal arcs may be the result of:

- external influences, e.g., tools forgotten inside the system, or any remaining material residues after maintenance or conversion work.
- conductive deposits on isolating supporting elements under unfavorable environmental conditions.

If the gases and decomposition products resulting from the faults described are capable of bridging the gap between two neighbouring phases, an arc will be ignited with current intensity of several thousand amperes and temperatures up to 10,000 °C. These conditions will result in a strong pressure build up inside the switchgear.

The resistance to internal arcs refers to two different aspects:

- Personal protection for the operator and maintenance personnel
- ASSEMBLY protection in order to limit the damage within the system and to quench the internal arc within specific areas and functional compartments.

Priorities for the arc fault protection in MNS

Priority 1

Active protection in MNS

The basic ABB MNS principle is that an arc fault should be prevented from occurring in the first place by designing and dimensioning the equipment to reduce this probability.

Priority 2

Passive protection in MNS

Limiting of the arc to the compartment where it occurs. This minimizes the consequences of an arc if it should occur.

Constructional measures to achieve optimized active and passive arc fault protection

Subject	IEC	Specific solution in MNS assuring high protection for Personnel and System
<p>Compartments for</p> <ul style="list-style-type: none"> - Busbars - Distribution bars - Functional units <p>These compartments are defined areas acc. IEC 61641, paragraph 5. The internal arc is restricted to these defined areas. For functional units which are part of one compartment (i.e. 8E/4, 8E/2, 6E/4 and 6E/2 withdrawable modules), the arc is restricted to the individual compartment for rated voltages > 500V.</p>	<p>IEC 61439-2 Paragraph 8.101 and Annex AA</p> <ul style="list-style-type: none"> - Forms of internal separation - No separation between busbars and distribution bars is required 	<p>Common compartment for the main busbars system.</p> <p>A separate compartment for the distribution bars embedded in the MNS Multi-Functional Wall (MFW) providing single phase isolation of distribution bars.</p> <p>For functional units which are directly connected to busbars such as ACBs, MNS utilizes a rigid arc barrier with gas-sealed connections between busbars and connection bars in order to provide a separate compartment.</p>
<p>Busbars:</p> <p>When forms of separation are required:</p> <ul style="list-style-type: none"> - Protection against contact with hazardous parts - Protection against the passage of solid foreign bodies <p>Fully single phase insulated busbars provide an arc free zone acc. to IEC 61641 paragraph 3.7.</p>	<p>Busbars are to be protected by internal separation:</p> <p>The required degree of protection shall be at least IP2X (or alternatively IPXXB).</p> <p>Note: IEC 61439-2 paragraph 8.101 Forms of internal separation IP2X covers IPXXB</p>	<p>The minimum degree of protection for internal separation is IP20.</p> <p>Option for maximum protection: The busbars are fully single phase insulated.</p>
<p>Busbar fastening and connections</p>	<p>The IEC 61439-1 and -2 does not give requirements in terms of maintenance and sealing of busbar fastening and connections.</p>	<p>Maintenance free design by thread locking bolts and conical spring washers. Gas-sealed connection between:</p> <ul style="list-style-type: none"> - busbars and distribution bars - busbars and bars of other functional units - busbars and connection bars to devices such as ACBs
<p>Main contact system</p>	<p>The IEC 61439-1 and -2 does not give requirements in terms of</p> <ul style="list-style-type: none"> - Single phase encapsulation - Main contact design 	<p>Single phase isolated contacts.</p> <p>The contact housing provides a rigid single phase isolation prior to connection of the contacts to the distribution bar.</p>

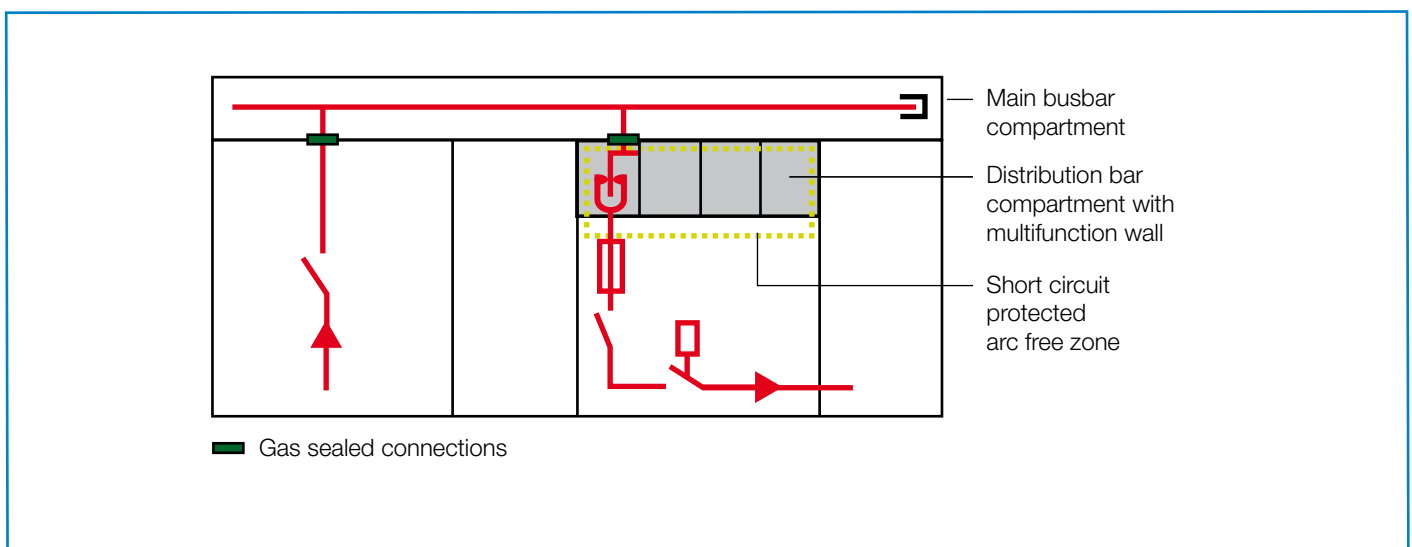

Arc Fault Protection

Constructional measures to achieve optimized active and passive arc fault protection

Subject	IEC	Specific solution in MNS assuring high protection for Personnel and System
Arc Free Zone	IEC 61439-1, Paragraph 8.6.4 Selection and installation of non-protected active conductors (before the SCPD ¹) to reduce the possibility of short circuits	Arc Free Zone is provided by the Multi-Functional Wall (MFW) and short-circuit protected cable with full double insulation. Guarantees higher safety between main busbars and SCPD ¹ .

Definition Arc Free Zone:

The term Arc Free Zone is used to describe the section within the cubicle consisting of the distribution bars, the main contact, and the supply side of the functional unit being the connection to the SCPD¹. According to IEC 61439-1 paragraph 8.6.1: "under normal operation an internal short-circuit between phases and/or between phases and earth is not to be expected (see 8.6.4)".

This allows manufacturers to reduce the short-circuit strength for the components including the distribution bars to the load connection terminals of each functional device, to the value of the reduced short circuit stress present on the load side of the SCPD¹.

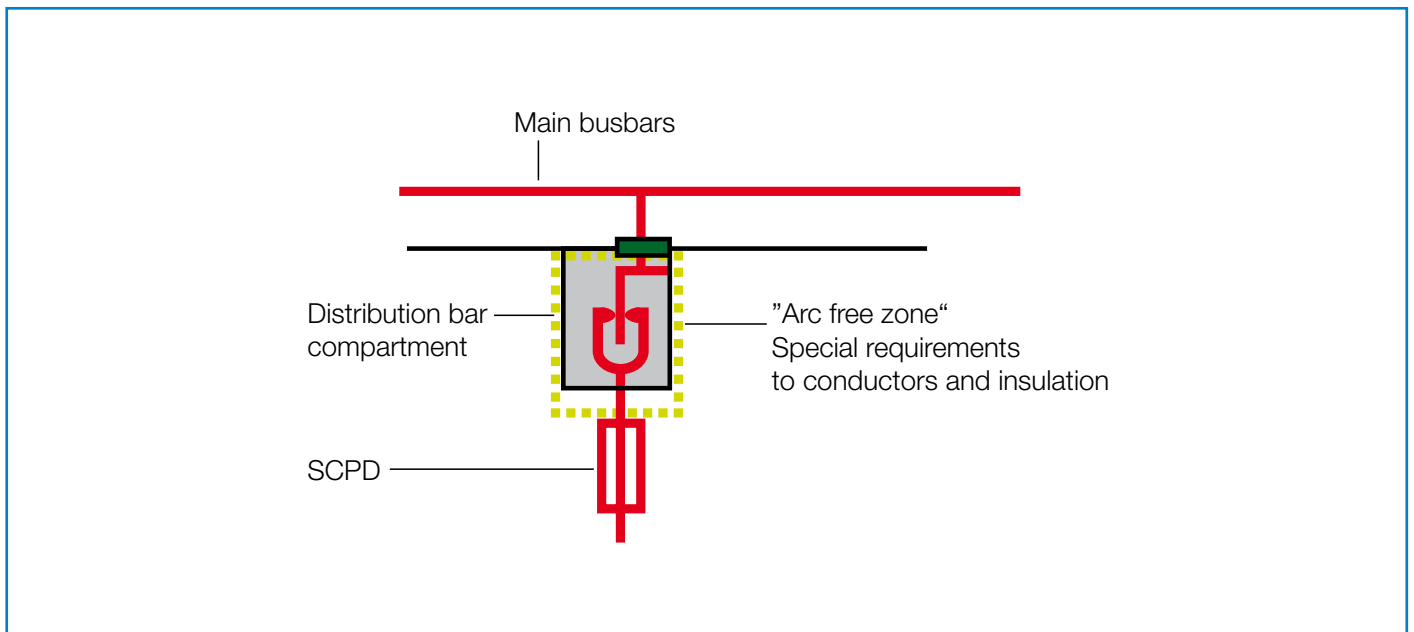

¹ SCPD: Short Circuit Protection Device

Subject	IEC	Specific solution in MNS assuring high protection for Personnel and System
<ul style="list-style-type: none"> - Comparative Tracking Index CTI - Material groups for Insulation purpose 	IEC 61439-1 Paragraph 8.3.3, table 2 Minimum required: Material Group IIIb = CTI value 100-175	MNS Standard: Material Group II = CTI value 400-600
Clearances <ul style="list-style-type: none"> - between busbars - between distribution bars at a Rated Impulse Withstand Voltage (U_{imp}) 12 kV 	IEC 61439-1 Paragraph 8.3.2 and table 1 Minimum required clearance: 14 mm	Minimum clearance in MNS is 20 mm.
Creepage distances between busbars	IEC 61439-1 Paragraph 8.3.3 and table 2 Minimum required distance: 14 mm at Rated Insulation Voltage = 1000 V	Creepage distances in MNS main busbar system are 30 mm.
Creepage distances between distribution bars	IEC 61439-1 Paragraph 8.3.3 and table 2 Minimum required distance: 14 mm at Rated Insulation Voltage = 1000 V	Creepage distances in MNS distribution bar system are 20 mm.

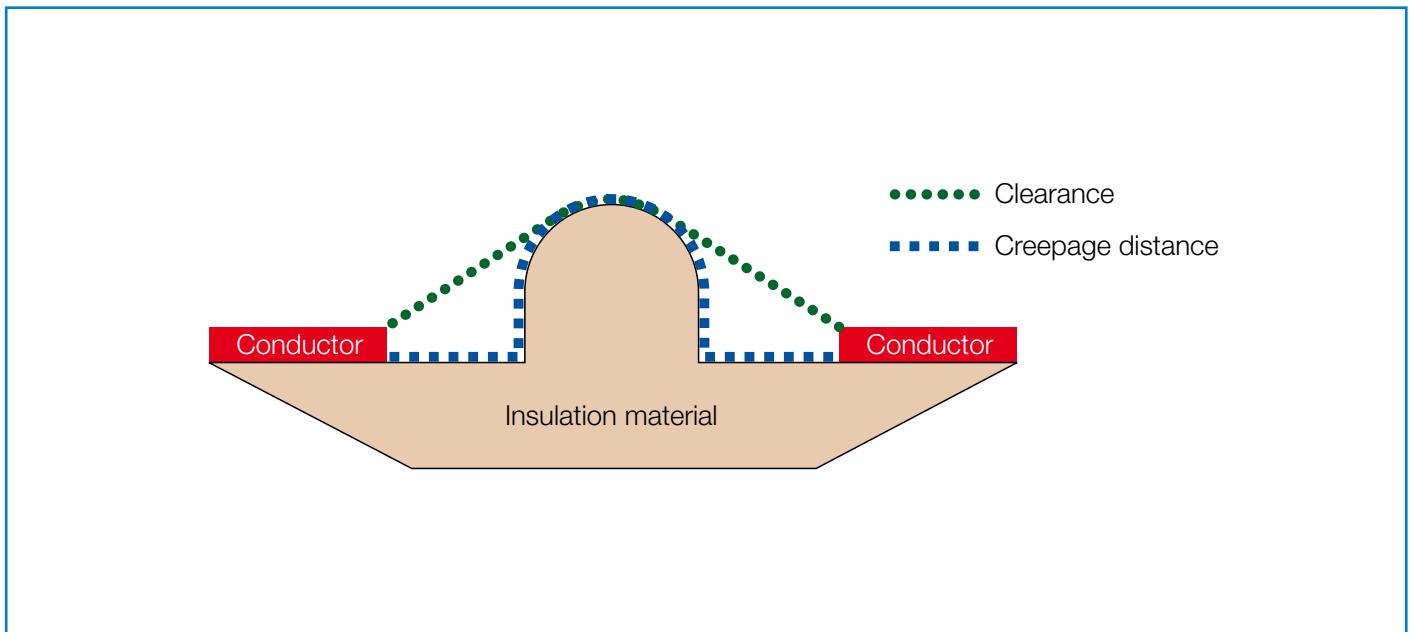

Arc Fault Protection

Test criteria arc fault withstand

IEC 61641

Test criteria 1-5 for personal protection:

Criterion No.	
1	whether correctly secured doors, covers, etc., do not open.
2	whether parts (of the assembly), which may cause a hazard, do not fly off.
3	whether arcing does not cause holes to develop in the freely accessible external parts of the enclosure as a result of paint or stickers burning or other effects.
4	whether the indicators arranged vertically do not ignite (indicators ignited as a result of paint or stickers burning are excluded from this assessment).
5	whether the equipotential bonding arrangement for accessible parts of the enclosure is still effective.

Test criteria 6-7 for ASSEMBLY protection including system function protection:

6	the arc must be limited to the defined area and must not re-ignite in the adjacent areas.
7	an emergency operation of the switchgear and control gear assembly must be possible when the fault has been repaired and/or the functional units of the defined area have been isolated or removed. This requirement must be evidenced by an insulation test carried out at 1.5 times the rated operating voltage for 1 min.

Test execution and results for MNS

The required values for the arc fault withstand are verified through rated voltage, short-circuit withstand and short-circuit tripping time and are to be selected for the equipment which must be able to withstand. The permissible arc duration is 0.3 s.

Note from IEC 61641 about the duration of the tests:

When the assembly is intended to be fed from a transformer, the permissible arc duration of the incoming switching device should in general be 0.3 s to allow the operation of the high-voltage protective equipment.

Results for MNS:

- Test criteria 1-5 for personal protection are fulfilled
- Test criteria 6-7 for ASSEMBLY protection are fulfilled together with the use of Multi-Functional Wall for functional units connected to distribution bars and rigid arc-barriers for functional units directly connected to busbars, all in combination with gas-sealed connections.



Points of arc fault ignition:

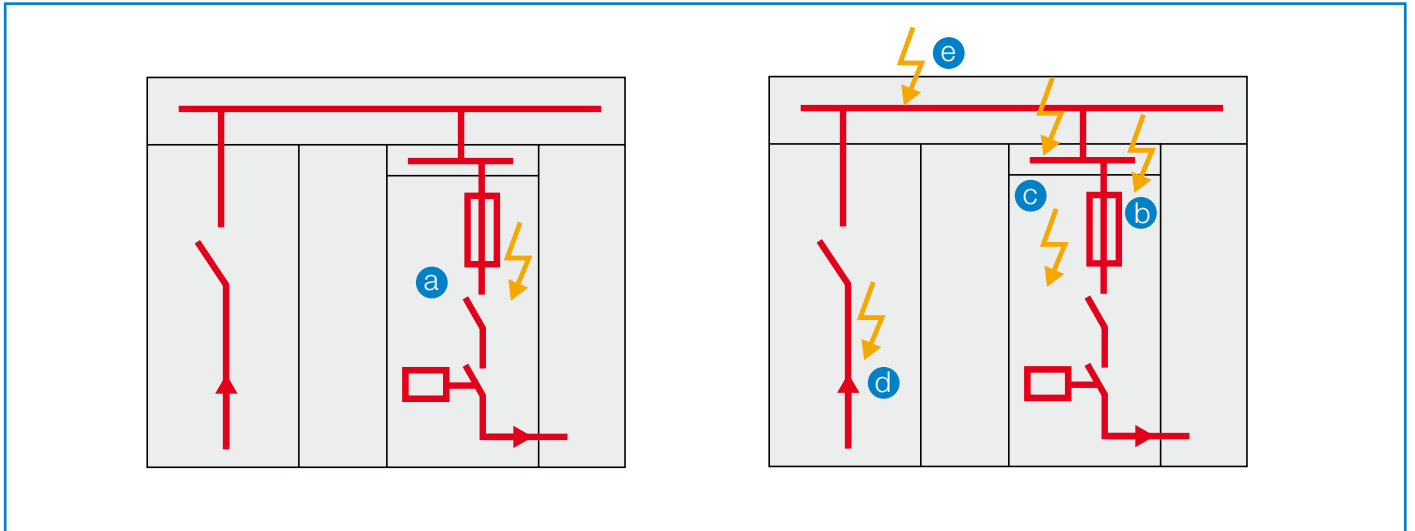

Note: Arc fault test at ignition point b) and c) is not required as they are located in the Arc Free Zone. Refer to IEC 61439-1 Paragraph 8.6.4. However MNS is fully tested to meet these criteria.

Ignition point a

Outgoing side of the SCPD of the withdrawable module (fuse or MCCB short circuit limiting breaker). The power is switched off within the breaking time of the ACB of 0.3 s. In tests the time was between 2 -10 ms. The arc is self extinguishing. The switchboard remains in operation.

Ignition point b

Incoming side of the SCPD of the withdrawable module (short circuit current not limited by the SCPD). The components are tested to resist an arc fault duration of 0.3 s.

Ignition point c

Distribution bars embedded in the Multi-Functional Wall
The components are tested to resist an arc fault duration of 0.3 s. The fault arc is self extinguishing.

Ignition point d

Incomer cubicle - before the ACB

The time for the duration of the fault arc is limited by the "test set up" (source) to 0.3 s. To reduce damage, MNS is designed as follows:

Case d1)

Tests have confirmed the following philosophy:
There is no fault arc barrier between the incoming and outgoing contacts of the ACB.
An fault arc ignited on the incoming side (not protected side) of the ACB moves to the outgoing side (protected side) of the ACB.

The current is instantaneously switched off by the ACB within adjusted tripping time (less than 0.3 s) of the ACB. The fault arc is self extinguishing. The damage is limited to a low level.

Case d2)

The fault arc is not limited by the ACB. The fault arc ignited on the incoming side (not protected side) of the ACB. The fault arc is inhibited to move to the outgoing side (protected side) of the ACB. The components resist the fault arc at a duration of 0.3 s. The current is switched off by the test setup after 0.3 s. The fault arc is self extinguishing.

Ignition point e

Main busbars

Case 1 - Fully insulated busbars

Fully insulated busbars, no root point: it is not possible to ignite an arc fault.

Case 2 - Non-insulated busbars

During this test the ACB in the incomer cubicle is mechanically prevented to trip.

The fault arc runs to the end of the busbars. The power switches off after max. 0.3 s. The fault arc is self extinguishing at the end of the switchgear.

Case 3 - Connection bars to ACB

During this test the ACB in the incomer cubicle is limiting the short circuit current. The current is instantaneously switched off by the ACB within the adjusted tripping time of the ACB in less than 0.3 s. The fault arc is self extinguishing. The damage is limited to a low level.

Degrees of Protection provided by enclosures (IP Code)

The degree of protection provided by any assembly against contact with live parts, ingress of solid foreign bodies and liquid is indicated by the designation IP... according to IEC 60529.

The degree of protection is also a criteria for design verification (IEC 61439-1 paragraph 10.3). It is subject to agreement between the manufacturer and user (IEC 61439-2 Annex BB).

Definitions

Degrees of protection provided by enclosures of electrical equipment in accordance with IEC 60529:

1. Protection of persons against access to hazardous parts inside the enclosure;
2. Protection of the equipment inside the enclosure against ingress of solid foreign objects;
3. Protection of the equipment inside the enclosure against harmful effects due to the ingress of water.

Designation for the degrees of protection:

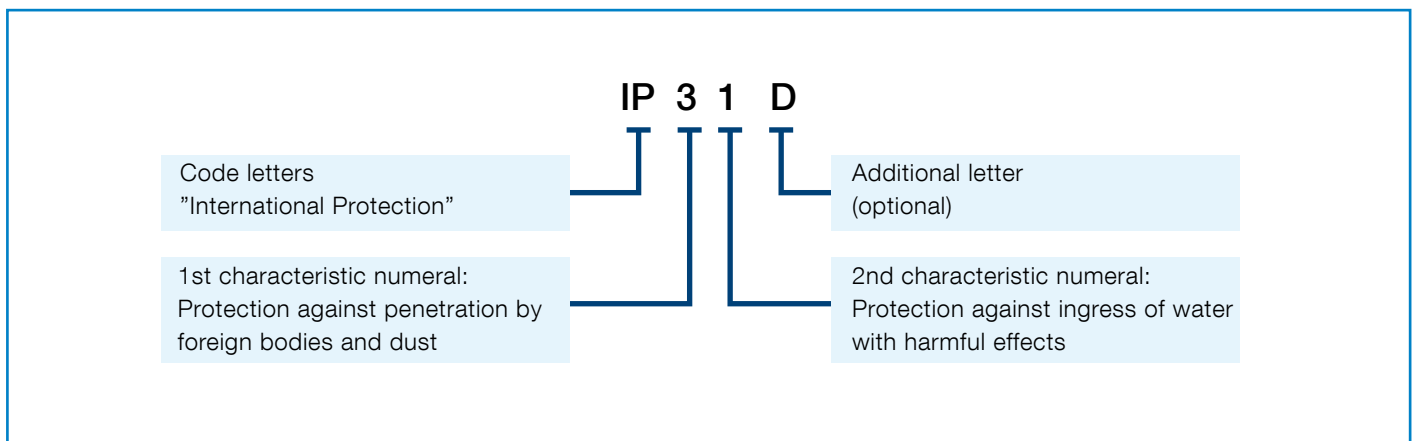







Remark

Where a characteristic numeral is not required to be specified, it shall be replaced by the letter "X" ("XX" if both numerals are omitted).

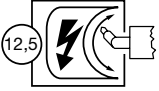
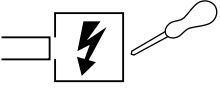
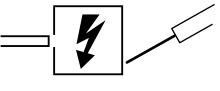
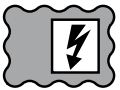
MNS – Available standard degrees of protection

As MNS is designed for indoor applications, no IP degrees covering water jetting and total water immersion are foreseen.

Ventilated		Non-ventilated
Ventilation grids in: Doors, covers and roof plate		Sealed; no ventilation openings
IP30	IP40	
IP31	IP41	
IP32	IP42	
	IP43	
		IP54
Maximum heat dissipation (by air convection)	→	Low heat dissipation (heat emission via enclosure only)

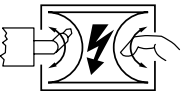
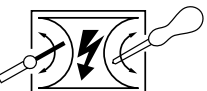
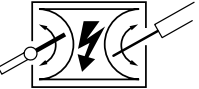
Subject	Protection of equipment	Protection of persons
First characteristic numeral	Protection against ingress of solid foreign objects	Protection against access to hazardous parts with:
2 	≥ 12.5 mm Diameter	Finger
3 	≥ 2.5 mm Diameter	Tool
4 	≥ 1.0 mm Diameter	Wire
5 	dust-protected	Wire
Second characteristic numeral	Protection against ingress of water with harmful effects	
0 	No Protection	
1 	Water vertically dripping (e. g. condensation water)	
2 	Water vertical dripping. The enclosure is tilted at any angle up to 15° on either side of the vertical	
3 	Water sprayed at an angle up to 60° on either side of the vertical	
4 	Water splashed against the enclosure from any direction	
Additional Letter (Optional)		Protection against access to hazardous parts with:
A		Back of the hand ≥ 50 mm diameter
B 		Finger / Tool ≥ 12.5 mm diameter, 80 mm length
C 		Tool / Wire ≥ 2.5 mm diameter, 100 mm length
D 		Tool / Wire ≥ 1.0 mm diameter, 100 mm length

Internal Separation

The internal separation is subject to agreement between the manufacturer and user (IEC 61439-2 paragraph 8.101, ANNEX AA Internal separation of PSC-ASSEMBLIES). Assemblies are divided by means of partitions or barriers (metallic or non-metallic) into separate compartments or enclosed protected spaces.

Aim: Whenever access to a functional unit is required (for extensions or maintenance), it should be possible without de-energizing the entire Low Voltage assembly.

Solution: The internal separation increases the safety for the personnel and the plant. Protection against direct contact can be obtained by appropriate constructional measures on the assembly itself. The risk to cause an internal arc failure is minimized.

Forms of internal separation

	Form 1	Form 2b	Form 4a	Form 3b	Form 4b
Internal Separation	No separation	Separation of busbars including distribution bars from the functional units and terminals for external conductors: Forms 2b, 4a, 3b, 4b	Separation of all functional units from another: Forms 4a, 3b, 4b	Separation of terminals for external conductors from the functional units: Forms 3b, 4b	Terminals not in the same compartment as associated unit: Form 4b
Protection of Persons	No protection when doors are open	Persons are protected against touch of busbars and distribution bars during work on the functional units: Forms 2b, 4a, 3b, 4b	Persons are protected against touch of neighbouring functional units during work on a functional unit: Forms 4a, 3b, 4b	Additional protection during work on the terminals for external conductors: Forms 3b, 4b	Protection to terminals of the neighbouring functional units: Form 4b
Protection of Equipment	No internal protection	Protection against ingress of foreign objects between functional unit into the bus bar compartment: Forms 2b, 4a, 3b, 4b	Protection against ingress of foreign objects into any neighbouring functional unit: Forms 4a, 3b, 4b	Protection against ingress of foreign objects between functional units and common terminal compartment: Forms 3b, 4b	Protection against ingress of foreign objects between single terminal compartments: Form 4b

MNS technique complying with forms of separation

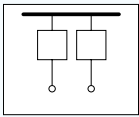
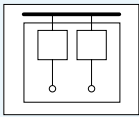
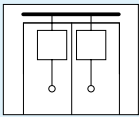
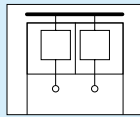
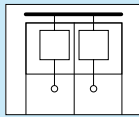
	Form 1	Form 2b	Form 4a	Form 3b	Form 4b
MNS Solution					
	On behalf of safety, MNS is only available with higher protection	In addition MNS provides a separate compartment also for the distribution bars by the MNS Multi Function Wall	MNS provides a separate cubicle for functional units with direct connection to main busbars	Each phase isolated as Form 4b	At MNS withdrawable modules each phase at the terminals for external conductors is isolated.

Special measures in MNS exceeding IEC regulations

All separation solutions fulfill the requirements of the degree of protection IP20.

Form 2b through 4b for functional units connected to distribution bars

If internal separation is required for functional units connected to distribution bars MNS offers additional safety by the use of the Multi-Functional Wall (MFW). The MFW is a separate compartment for the distribution bars. It provides a single phase isolation of distribution bars and a "gas-sealed" connection between the main busbars and the distribution bars.

The degree of protection between the distribution bars and equipment compartment (functional unit) using the MFW is IP20 without the necessity of moving parts (shutters etc.).

Form 2b and 4a for functional units which are directly connected to busbars

Switchboards with functional units which are directly connected to busbars. Mainly used for incomers, bus-ties and outgoing feeders utilizing MNS rigid arc-barriers for a higher degree of internal separation.

Form 3b and 4b for withdrawable functional units connected to distribution bars

For switchboards with withdrawable modules with individual module compartments separated by compartment bottom plates.

Earthquake, Vibration and Shock

MNS was successfully tested according to:

- IEC 60068-2-6 (Vibration)
- IEC 60068-2-27 (Single shock)
- Germanischer Lloyd, Lloyd's Register of Shipping

Standard Execution

According to the standards listed above, the standard version of MNS (when erected with floor connection, i.e. without any additional reinforcement of the frame, the modules, etc.) is resistant to stress caused by vibration and shock up to 0.7 g (vertical, horizontal, diagonal).

The functional safety of the equipment, contacts and connections in compliance with the standard is guaranteed within MNS. For example, the screwed system connections have been proven to resist continuous stress resulting from vibration of excavators or on ships, providing the recommended maintenance intervals are observed.

Individual solutions

In the event of additional requirements concerning the earthquake resistance of a plant in individual cases, the following data must be provided for project engineering and, if necessary, testing a specifically adjusted plant design:

- the stress to be expected in the place of erection
- the acceleration to be expected in the event of an earthquake
- the frequency range and the response range of the building

These increased demands can be met, e.g.:

- by installing the system on shock absorbers or alternatively
- by using shock-proof equipment
- by reinforcing the frame, the enclosure and other system parts



Neutral conductor dimensioning

The basic requirement in IEC 61439-1 for the Neutral conductor (paragraph 8.6.1) and for the PEN conductor (paragraph 8.4.3.2.3) is

- up to 16mm²: 100% of the phase cross-section and
- above 16mm²: 50% of the phase cross-section.

However, this shall be clarified acc. to IEC 61439-1, Annex C, "Items subject to agreement between manufacturer and user", with respect to the size of the Neutral or PEN conductor.

If one or several of the operating conditions described below are present, an agreement between user and manufacturer may define Neutral or PEN conductors larger than 50% of the phase cross-section or may accept the MNS standard sizing.

Technical background

Various electrical components used today may cause undesirable neutral conductor currents. These undesirable neutral conductor currents result from harmonics and may even exceed the value of the phase current.

This refers to, e.g.:

- Rectifiers, especially if they are equipped with power factor correction
- Power supply units without transformers, e.g. switched-mode power supplies of computers
- Lamps with electronic ballasts
- Phase-controlled inverters and controllers, e.g. frequency inverters

In reality the equipment mentioned above is often connected on the same network and utilised simultaneously.

A considerable load on the neutral conductor has to be expected based on the 3rd harmonic (150Hz in the 50Hz system) because the phase currents of this frequency do not equal each other out, but rather add up, flowing back to the generator in the neutral conductor causing overheating.



Contact us

ABB Low Voltage Systems

Publication Editor:

ABB Automation Products GmbH

Ladenburg, Germany

Local Contacts on

www.abb.com/mns

Note:

We reserve the right to make technical changes or modify the contents of this document without prior notice. With regard to purchase orders, the agreed particulars shall prevail. ABB does not accept any responsibility whatsoever for potential errors or possible lack of information in this document.

We reserve all rights in this document and in the subject matter and illustrations contained therein. Any reproduction, disclosure to third parties or utilization of its contents – in whole or in parts – is forbidden without prior written consent of ABB.

Copyright© 2012 ABB

All rights reserved

Publication no. 1TGC900009B0202 Rev. 02, Sept. 2012